

Life Fitness

G2-001
G2 HOME GYM

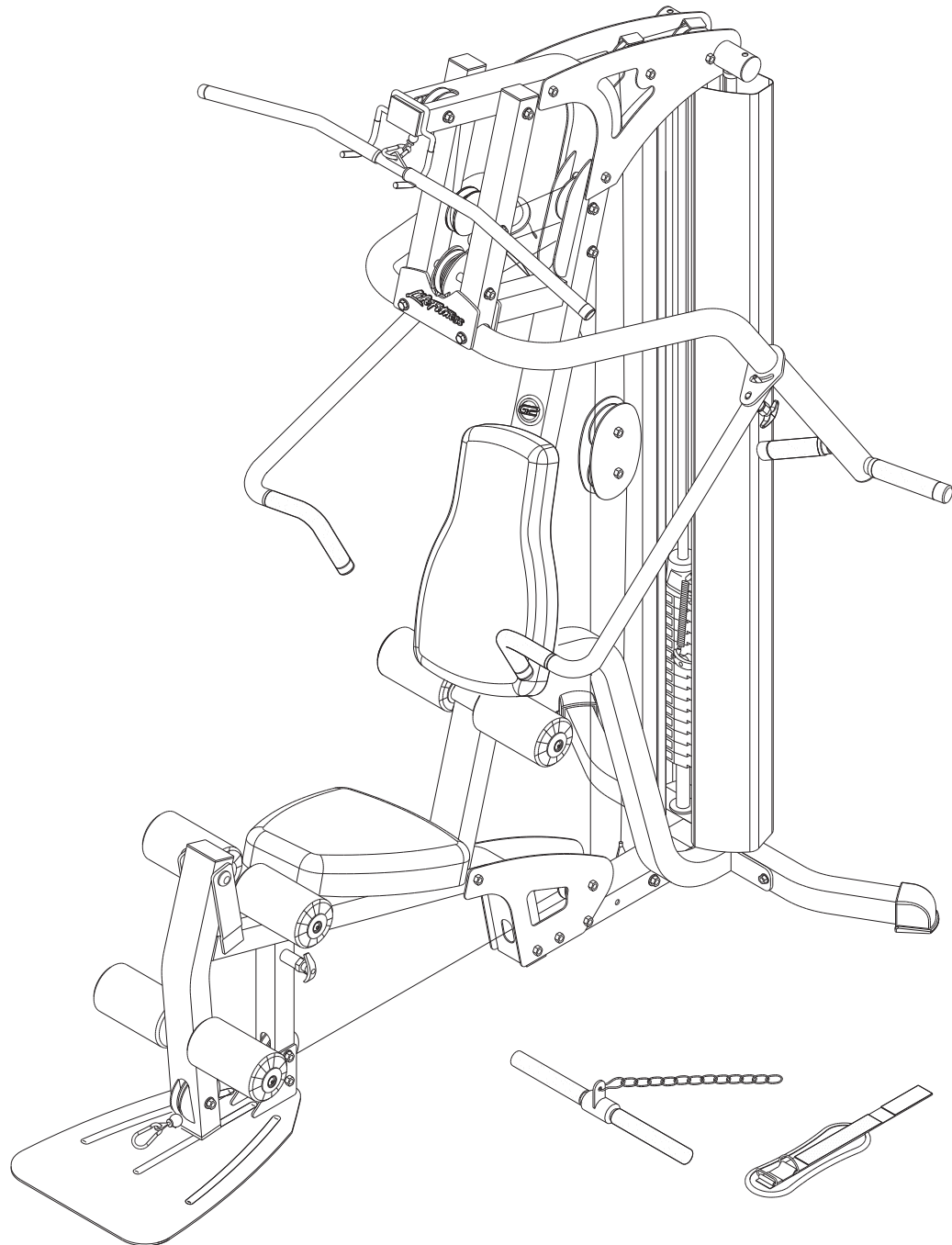

Customer Support Services
PARTS MANUAL

G2-001 G2 HOME GYM CONTENTS

	PAGE
COMPONENT ASSEMBLY I	3
COMPONENT ASSEMBLY I LEGEND	4
COMPONENT ASSEMBLY II	5
COMPONENT ASSEMBLY II LEGEND	6
COMPONENT ASSEMBLY III	7
COMPONENT ASSEMBLY IV	8
CABLE ROUTING	9
WEIGHT STACK ASSEMBLY	10
SUPPLIED ACCESSORIES	11
LAT BAR ASSEMBLY	12
LOW ROW BAR ASSEMBLY	13
HARDWARE BAG	14

G2-001 G2 HOME GYM COMPONENT ASSEMBLY I

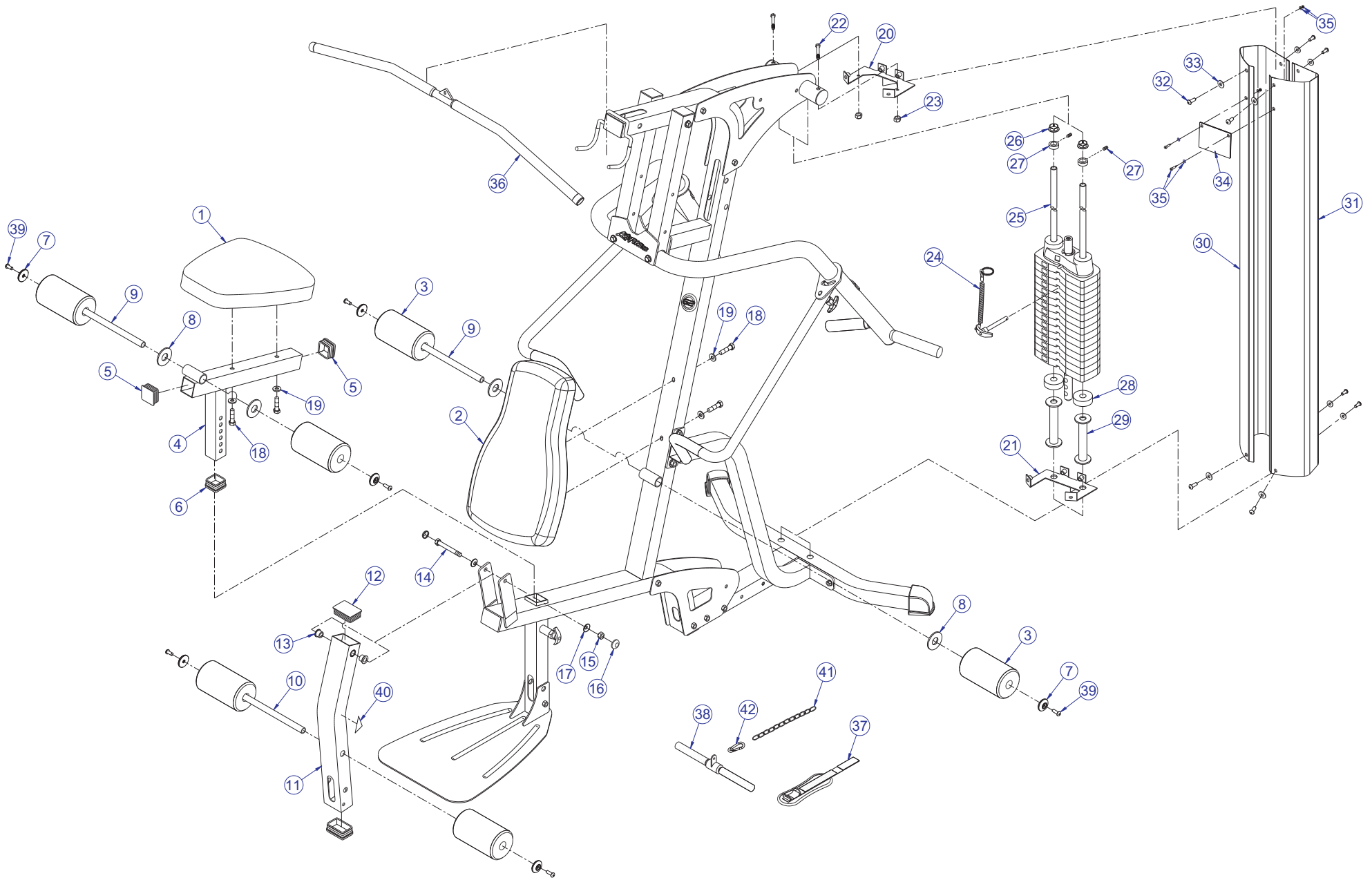

G2-001 G2 HOME GYM COMPONENT ASSEMBLY I LEGEND

ITEM NO.	QTY.	PART NO.	DESCRIPTION
1	1	8594301	PAD, CONSUMER, SEAT
2	1	8594201	PAD, CONSUMER, BACK
3	6	8578401	PAD, ROLLER
4	1	8585301	WLDMT, SEAT ADJUST
5	2	8585001	CAP, END 1-3/4
6	1	8585401	CAP, END 2 SQ
7	6	8598001	AL CAP, ROLLER PAD END
8	4	8584201	WASHER, PLASTIC
9	2	7316202	3/4 X 18-7/8 TUBE
10	1	7316201	3/4 X 17-7/8 TUBE
11	1	8577801	ASSY, LEG PEDESTAL
12	2	8582201	CAP, END 75 X 50
13	2	3267901	BEARING, FLANGE 1/2 ID X 5/8 OD
14	1	3102917	1/2-13X4 UNS HEX FHB G2 ZN
15	1	3268201	NUT, NYLOCK 1/2-13 LOW HT
16	2	8596001	CAP, RH
17	2	8597601	WASHER, 1/2 RHCAP HOLDER
18	4	3102904	3/8-16X3 UNS HEX FHB G2 ZN
19	4	3228501	WASHER, FLAT 3/8 ID SAE BZ
20	1	8595501	PTD ASSY, SHROUD BRKT - TOP
21	1	8595601	PTD ASSY, SHROUD BRKT - BTM
22	2	3235210	3/8-16 X2.50 UNS HEX FHB G2 BZ
23	2	3114702	NUT, NYLOCK 3/8-16 BZ
24	1	8587601	ASSY, WEIGHT STACK PIN
25	2	6523401	GUIDE ROD, 3/4 OD X 72-3/8
26	2	8579201	SOCKET BUSHING
27	2	3103302	SHAFT COLLAR, 13/16 ID ZINC
28	2	3108002	CUSHION, WEIGHT STACK 3/4 ID
29	2	8588601	WLDMT, WEIGHT STACK SPACER
30	1	8588901	SHROUD, RIGHT, G2
31	1	8589001	SHROUD, LEFT, G2
32	8	3202401	3/8-16 X 1 HXS BUT CS G8 BO
33	8	3228501	WASHER, FLAT 3/8 ID SAE BZ
34	8	8598501	EXERCISE CARDS, G2
35	2	8604201	MAGNET, CARD HOLDER
36	1	8585801	ASSY, LAT BAR, G2
37	1	6409101	STRAP, ANKLE STANDARD
38	1	8588301	ASSY, LOW ROW BAR
39	6	3268301	CAP SCREW, BTN HD 3/8-16 BO
40	2	8039501	LABEL, WARNING, TRIANGLE, BNR
41	1	6075906	CHAIN, 12 LINK
42	1	3103801	LINK, SNAP 5/16 DIA

G2-001 G2 HOME GYM COMPONENT ASSEMBLY II

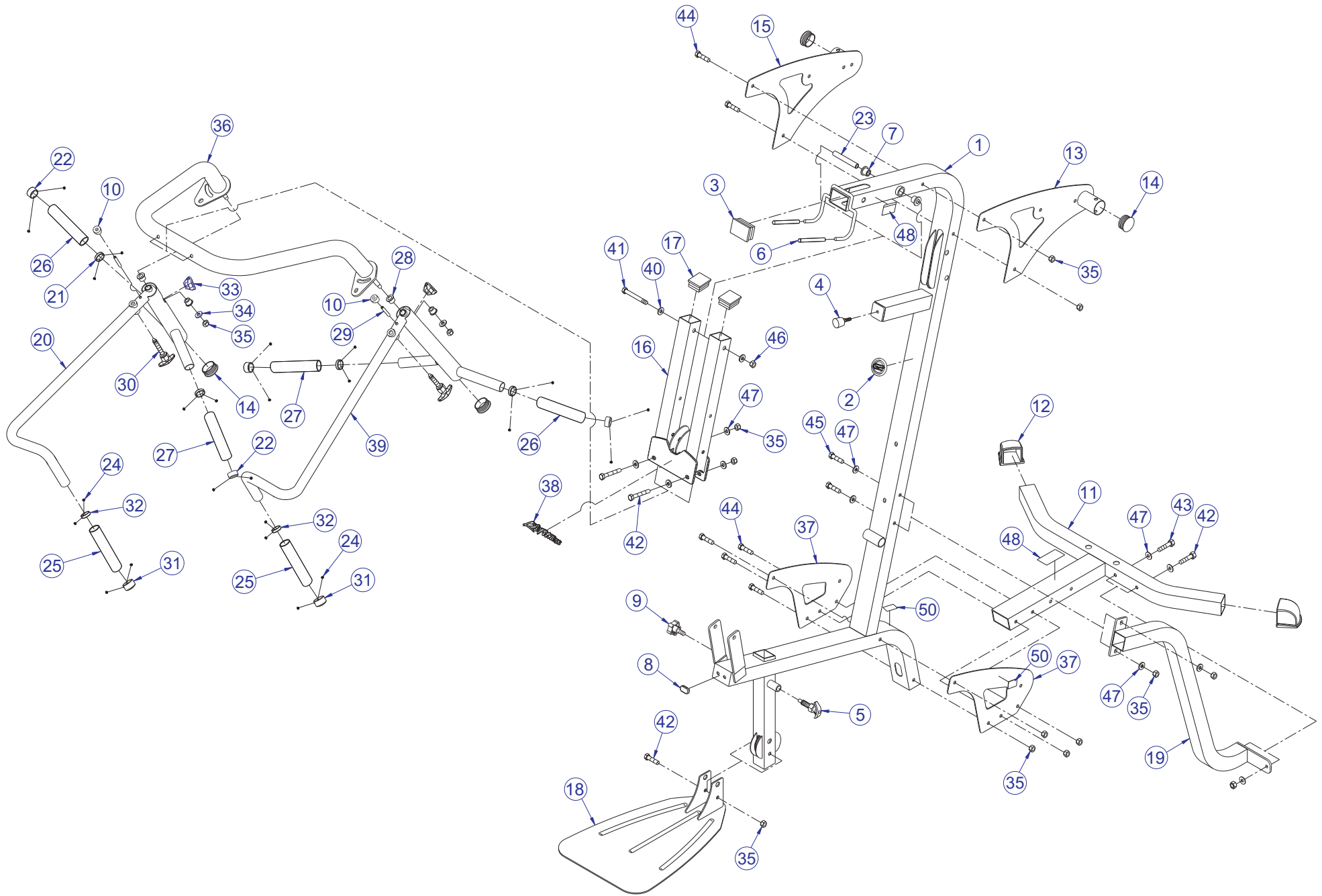

G2-001 G2 HOME GYM COMPONENT ASSEMBLY II LEGEND

ITEM NO.	QTY.	PART NO.	DESCRIPTION
1	1	8581801	ASSY, FRAME, G2
2	1	8582401	G2 MODEL NUMBER LABEL
3	1	8582201	CAP, END 75 X 50
4	1	8584301	ADJUSTABLE GLIDE
5	1	8582001	T-HANDLE SPRING PIN
6	2	8582101	LAT BAR HOOK COVER - 3/8 ID X 4-3/8 L
7	2	3104901	BEARING, FLG .75 ID X 1.00 OD
8	1	8610001	BUMPER
9	1	8580401	KNOB, SEAT ADJUSTER
10	2	8589101	SPACER, PRESS ARM
11	1	8582501	ASSY, BASE, G2
12	2	8582701	CAP, COVER 2 X 2
13	1	8582901	ASSY, BOOM PLATE LEFT
14	4	8578501	CAP, END DIA 50.8
15	1	8583301	ASSY, BOOM PLATE RIGHT
16	1	8584801	ASSY, PRIMARY PIVOT
17	2	8585001	CAP, END 1-3/4
18	1	8587801	WLDMT, FOOT PLATE
19	1	8588001	WLDMT, FRAME BRACE, G2
20	1	8583501	ASSY, PRESS HANDLE RIGHT
21	4	7662801	RING, GRIP 1.25 OD
22	4	7662901	CAP; GRIP 1.25 OD
23	1	8597801	SHAFT, 3/4 X 4
24	24	3247701	M4 X 0.7 X 3 HZS NO CUP ST BO
25	2	8583901	HAND GRIP - 31.5 OD X 300L
26	2	8583701	HAND GRIP - 25 OD X 120L
27	2	8583801	HAND GRIP - 25 OD X 135L
28	4	3267901	BEARING, FLANGE 1/2 ID X 5/8 OD
29	2	3110005	ROLL PIN, 5/16 DIA X 2
30	2	7284901	TAPER/LOCK SPRING PIN
31	2	8587901	CAP AL 38.1 OD X 32.3 ID X 22.2H
32	2	8588501	COLLAR, SHAFT, AL 32.5 OD X 11.1H
33	2	8598101	END CAP, OVAL, G2
34	2	3228501	WASHER, FLAT 3/8 ID SAE BZ
35	14	3102807	NUT, NYLOCK 3/8-16 LOW HT
36	1	8584701	WLDMT, PRESS ARM
37	2	8582801	BASE PLATE, G2
38	1	8580601	LABEL, LF LOGO 6.63
39	1	8584501	ASSY, PRESS HANDLE LEFT
40	2	3102512	WSHR, FLAT 1/2 ID X 1-3/4 OD ZN
41	1	3102971	1/2-13 X 8-3/8 UNS HEX FHB G2 ZN
42	4	3102904	3/8-16X3 UNS HEX FHB G2 ZN
43	1	3102903	3/8-16 X 2-1/2 UNS HEX FHB G2 ZN
44	6	3102905	3/8-16 X 3-3/4 UNS HEX FHB G2 ZN
45	2	3102906	3/8-16X4 UNS HEX FHB G2 ZN
46	1	3102804	NUT, NYLOCK 1/2-13 LOW HT
47	11	3102514	WASHER, FLAT 3/8 IN SAE ST ZN
48	1	8582301	WARNING LABEL
49	1	8243001	LABEL, ASTM WARN SELECT SHEET
50	1	8605501	SERIAL NUMBER LABEL

G2-001 G2 HOME GYM COMPONENT ASSEMBLY III

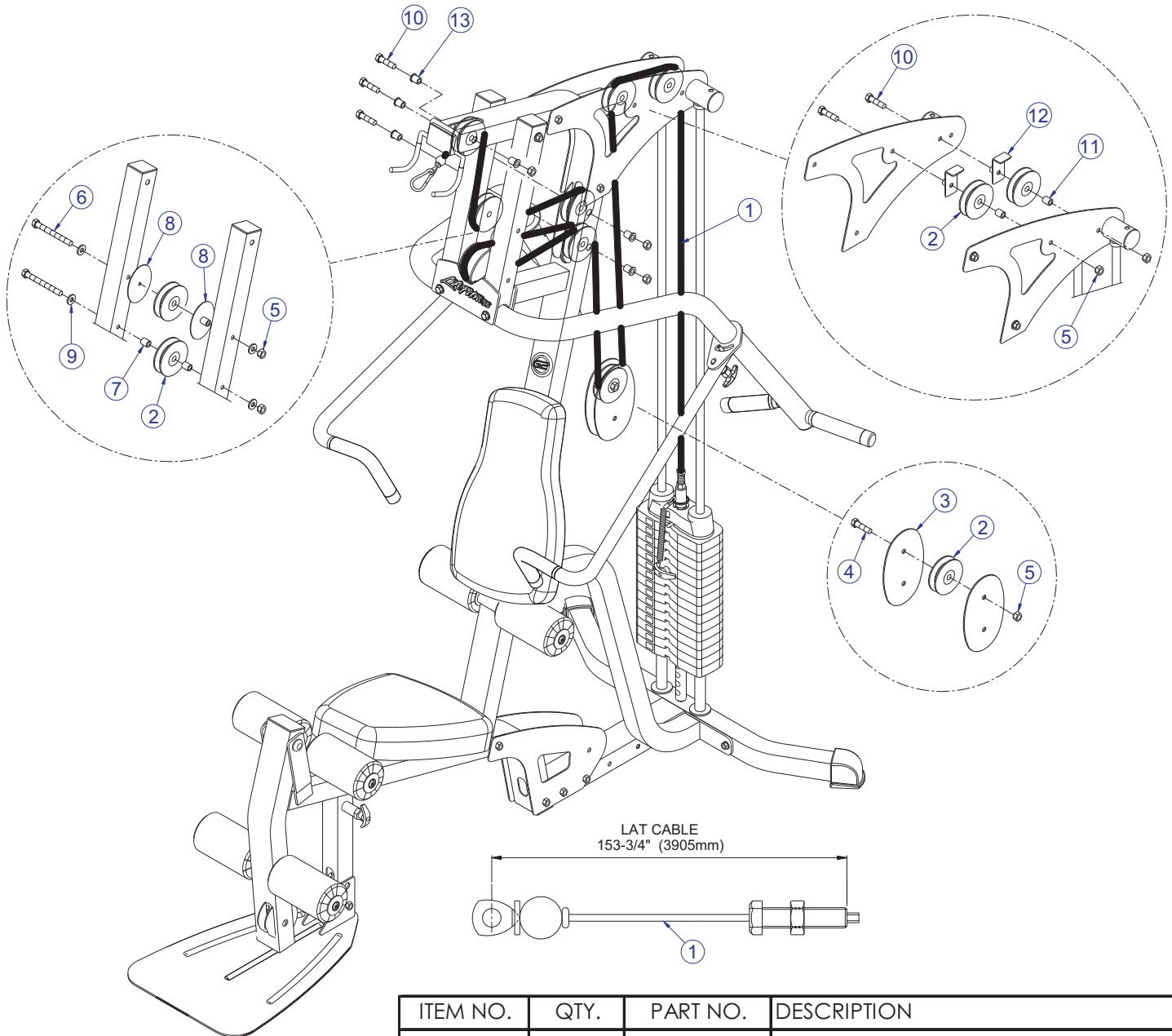

ITEM NO.	QTY.	PART NO.	DESCRIPTION
1	1	7014101	CABLE,SE,NB1-TP1,T1,151-7/8 LAT
2	8	3116201	PULLEY, 3-1/2 OD X 3/8 ID X 1
3	2	8595701	PLATE, DOUBLE PULLEY
4	1	3102924	3/8-16X1-3/4 UNS HEX FHB G2 ZN
5	8	3102807	NUT, NYLOCK 3/8-16 LOW HT
6	2	3102968	3/8-16 X 8-3/4 UNS HEX FHB G2 ZN
7	2	8597701	SPACER, 3/8 X 1-1/2 LG
8	2	8644601	WLDMT, PULLEY GUARD/SPACER G2
9	4	3102514	WASHER, FLAT 3/8 IN SAE ST ZN
10	5	3102905	3/8-16 X 3-3/4 UNS HEX FHB G2 ZN
11	2	8597702	SPACER, 3/8 X 1 LG
12	2	8588801	3-1/2 CABLE GUARD
13	6	3268101	SPACER, FLANGE 3/8 X 1-1/16

G2-001 G2 HOME GYM COMPONENT ASSEMBLY IV

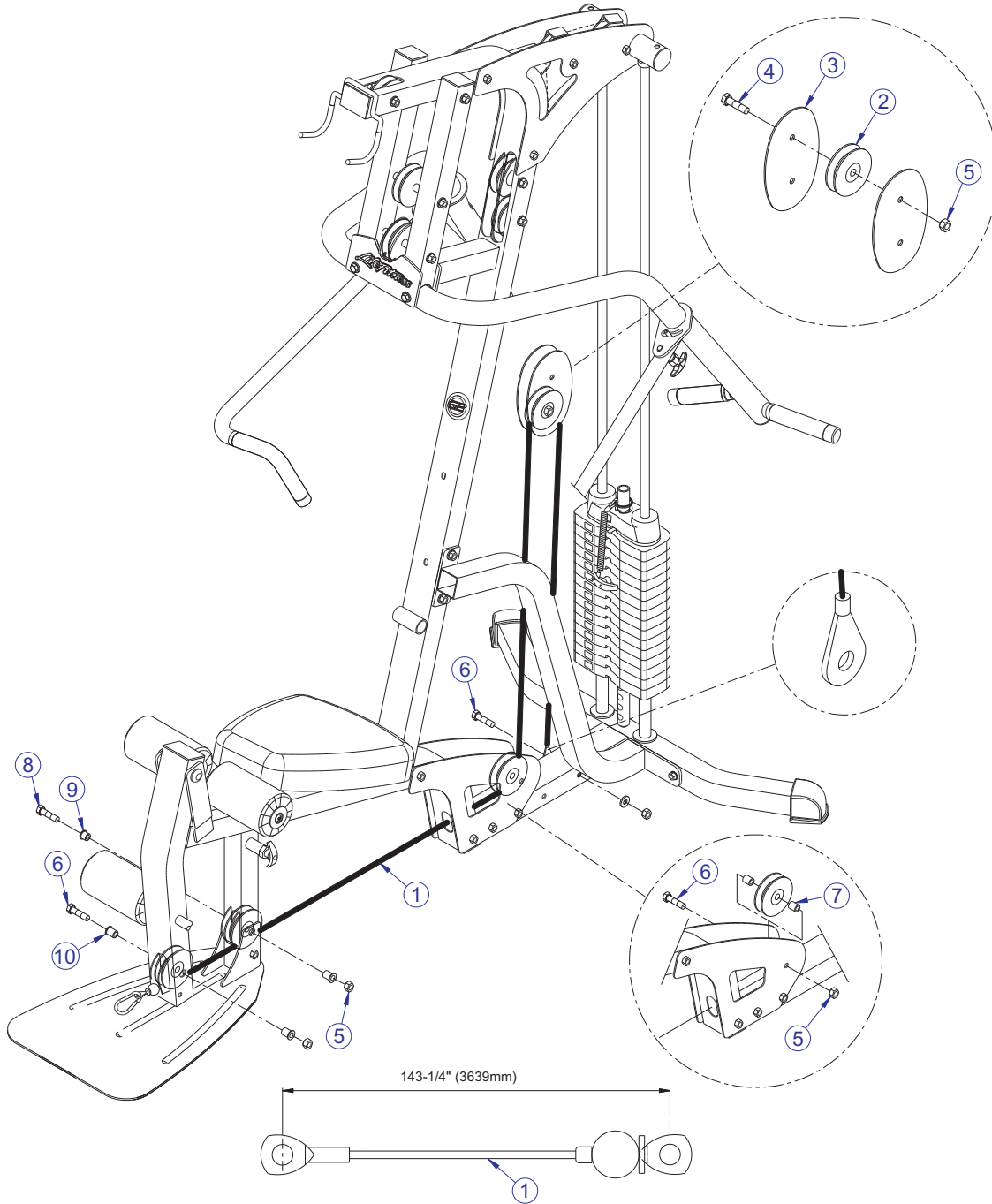

ITEM NO.	QTY.	PART NO.	DESCRIPTION
1	1	7014201	CABLE,SE-NB1,SE,143-1/4 LOW ROW
2	4	3116201	PULLEY, 3-1/2 OD X 3/8 ID X 1
3	2	8595701	PLATE, DOUBLE PULLEY
4	1	3102924	3/8-16X1-3/4 UNS HEX FHB G2 ZN
5	4	3102807	NUT, NYLOCK 3/8-16 LOW HT
6	3	3102905	3/8-16 X 3-3/4 UNS HEX FHB G2 ZN
7	2	8597702	SPACER, 3/8 X 1 LG
8	1	3102904	3/8-16X3 UNS HEX FHB G2 ZN
9	2	3268001	SPACER, FLANGE 3/8 X 3/4
10	2	3268101	SPACER, FLANGE 3/8 X 1-1/16

G2-001 G2 HOME GYM CABLE ROUTING

LAT CABLE:
7014101

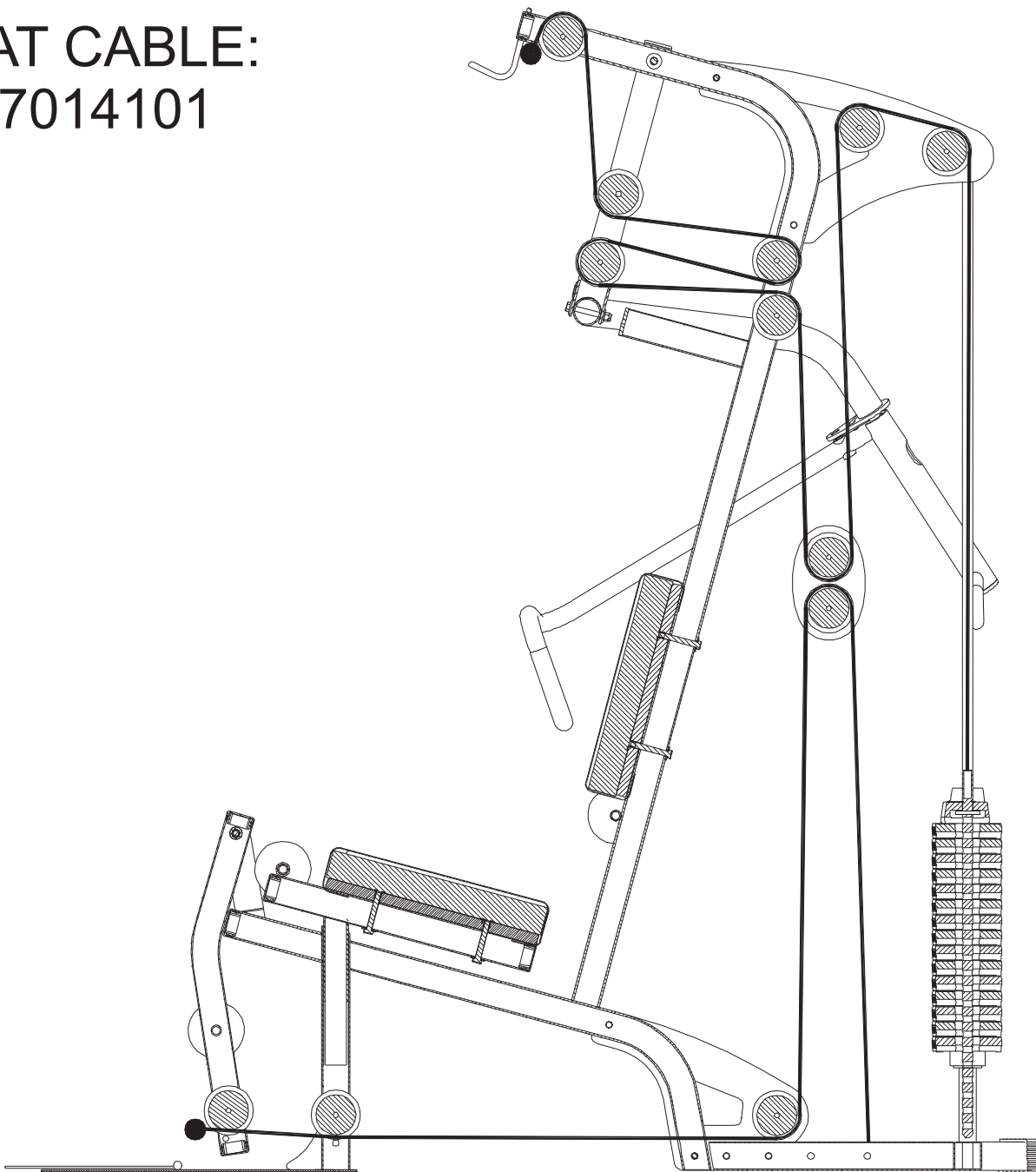

LOW ROW CABLE:
7014201

G2-001 G2 HOME GYM WEIGHT STACK ASSEMBLY

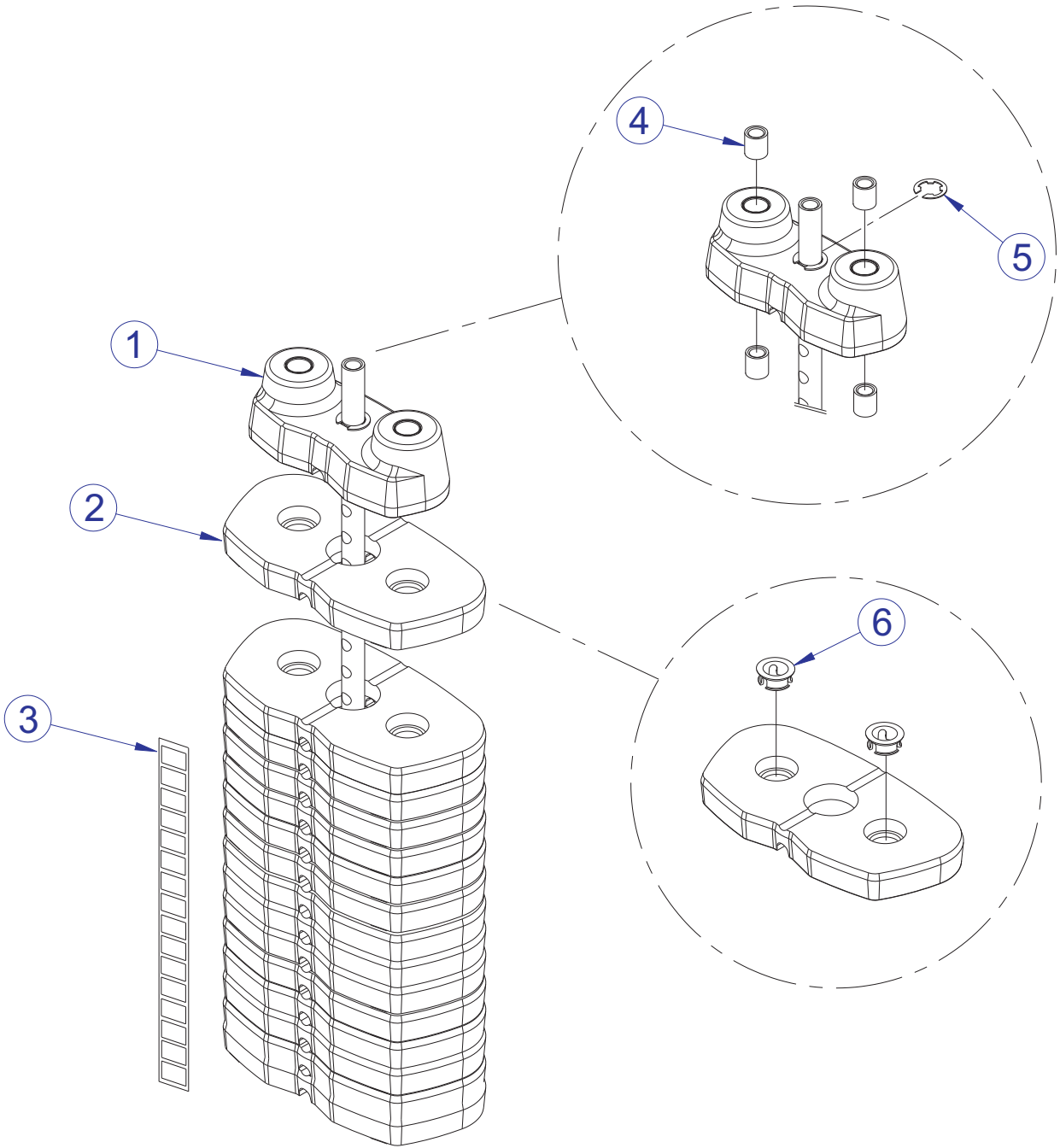

ITEM NO.	QTY.	PART NO.	DESCRIPTION
1	1	7292801	PTD ASSY, HEAD PLATE 20 HOLE
2	15	ACUWT-PLATE	215102 SINGLE WT PLATE 10 LBS
3	1	7308601	LABEL;WEIGHT STACK 1-26
4	4	7286601	BEARING,SLEEVE 20ID X23 X 15MM
5	1	3221702	E-RING, EXTERNAL 3/4
6	30	6224501	SOCKET BUSHING

G2-001 G2 HOME GYM SUPPLIED ACCESSORIES

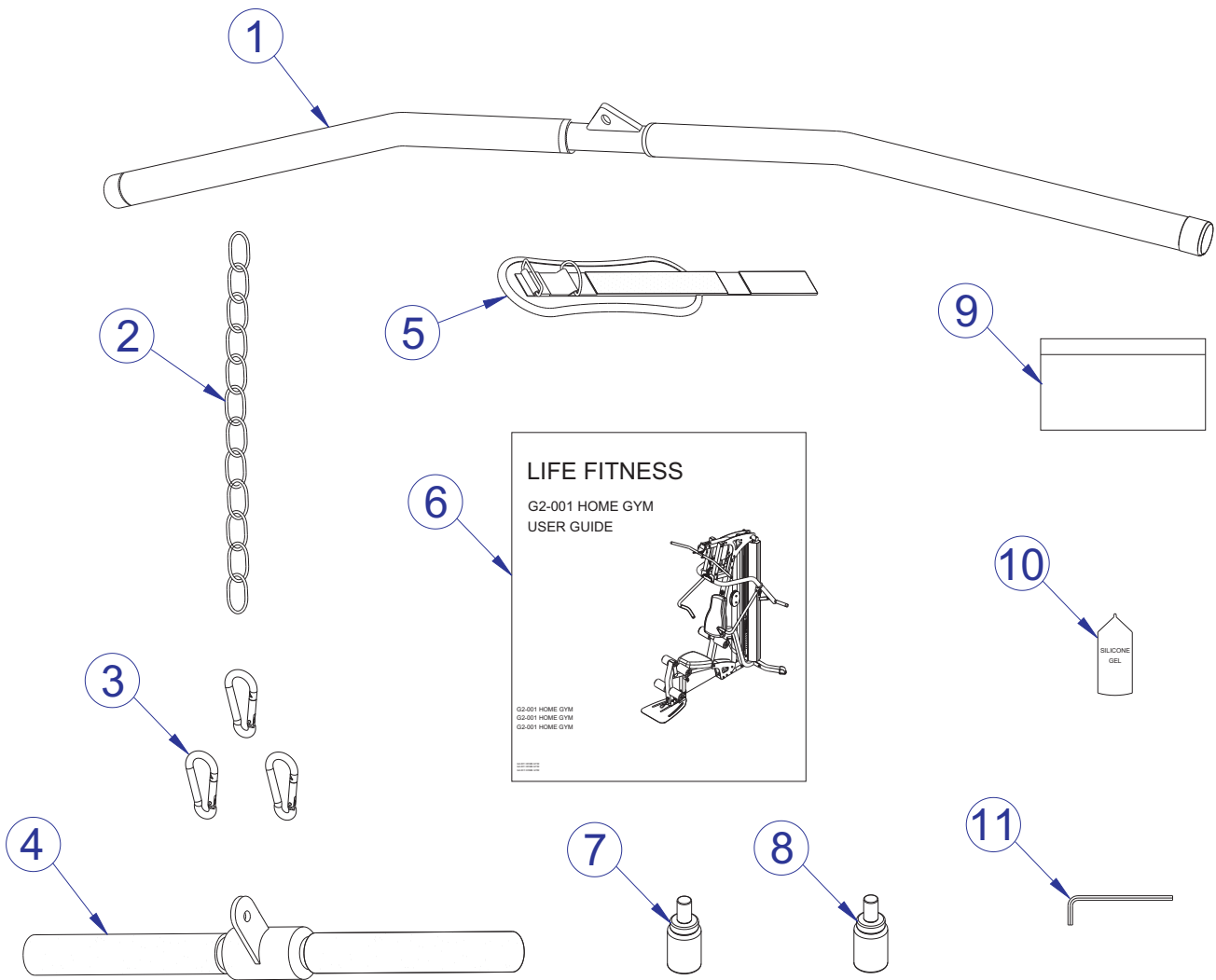

ITEM NO.	QTY.	PART NO.	DESCRIPTION
1	1	8585801	ASSY, LAT BAR, G2
2	1	6075906	CHAIN, 12 LINK
3	3	3103801	LINK, SNAP 5/16 DIA
4	1	8588301	ASSY, LOW ROW BAR
5	1	6409101	STRAP, ANKLE STANDARD
6	1	8598201	USER GUIDE & WARRANTY CARD
7	1	8599601	PAINT, TOUCH UP, SHADOW GREY
8	1	8598401	PAINT, TOUCH UP, PLATINUM
9	8	8598501	EXERCISE CARDS, G2
10	1	8598301	SILICONE GEL
11	2	8610401	ALLEN WRENCH M5

G2-001 G2 HOME GYM LAT BAR ASSEMBLY - 8585801

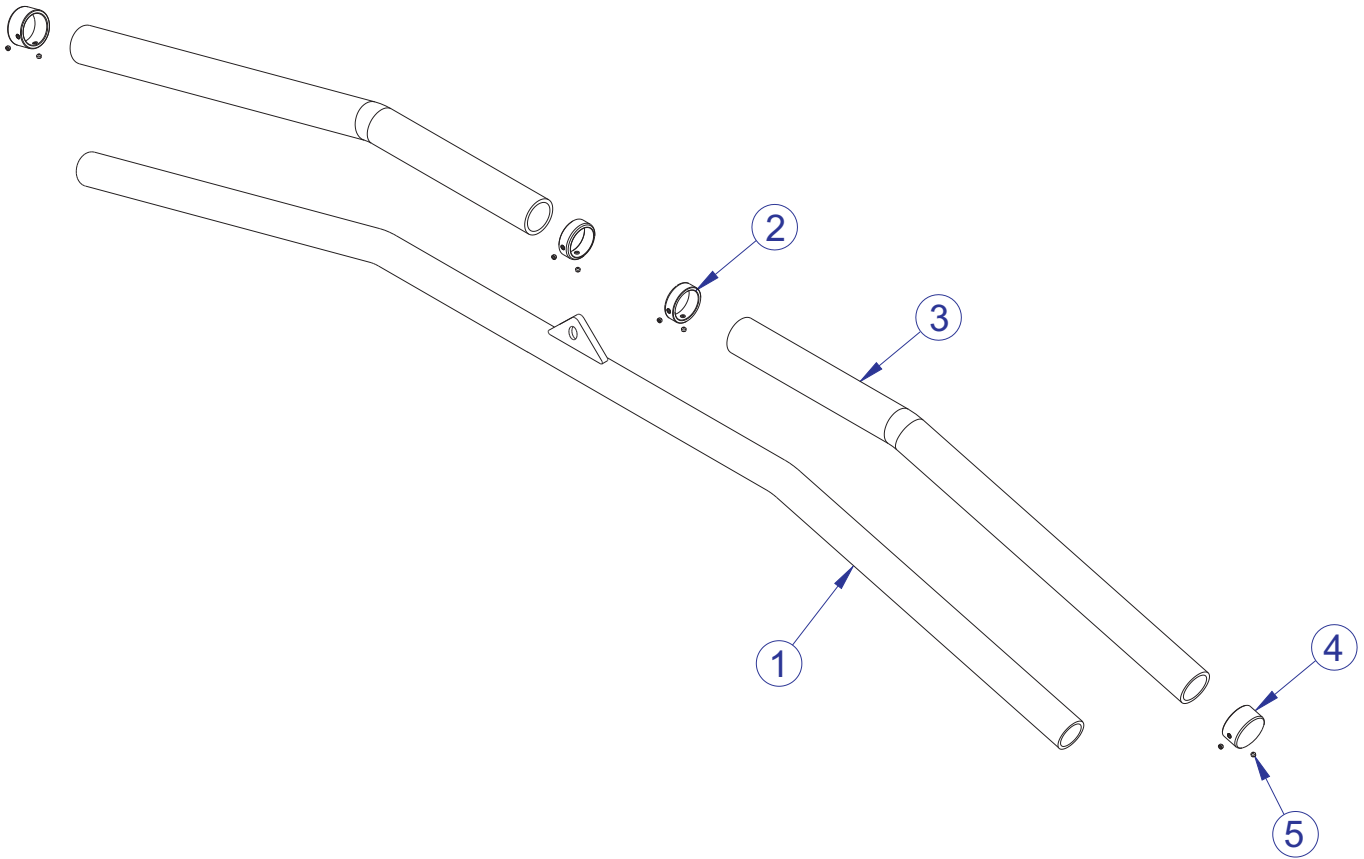

ITEM NO.	QTY.	PART NO.	DESCRIPTION
1	1	8585801	ASSY, LAT BAR, G2
2	2	8596801	HAND GRIP - 25 X 580L
3	2	7662801	RING, GRIP 1.25 OD
4	2	7662901	CAP; GRIP 1.25 OD
5	8	3247701	M4 X 0.7 X 3 HZS NO CUP ST BO

G2-001 G2 HOME GYM LOW ROW BAR ASSEMBLY

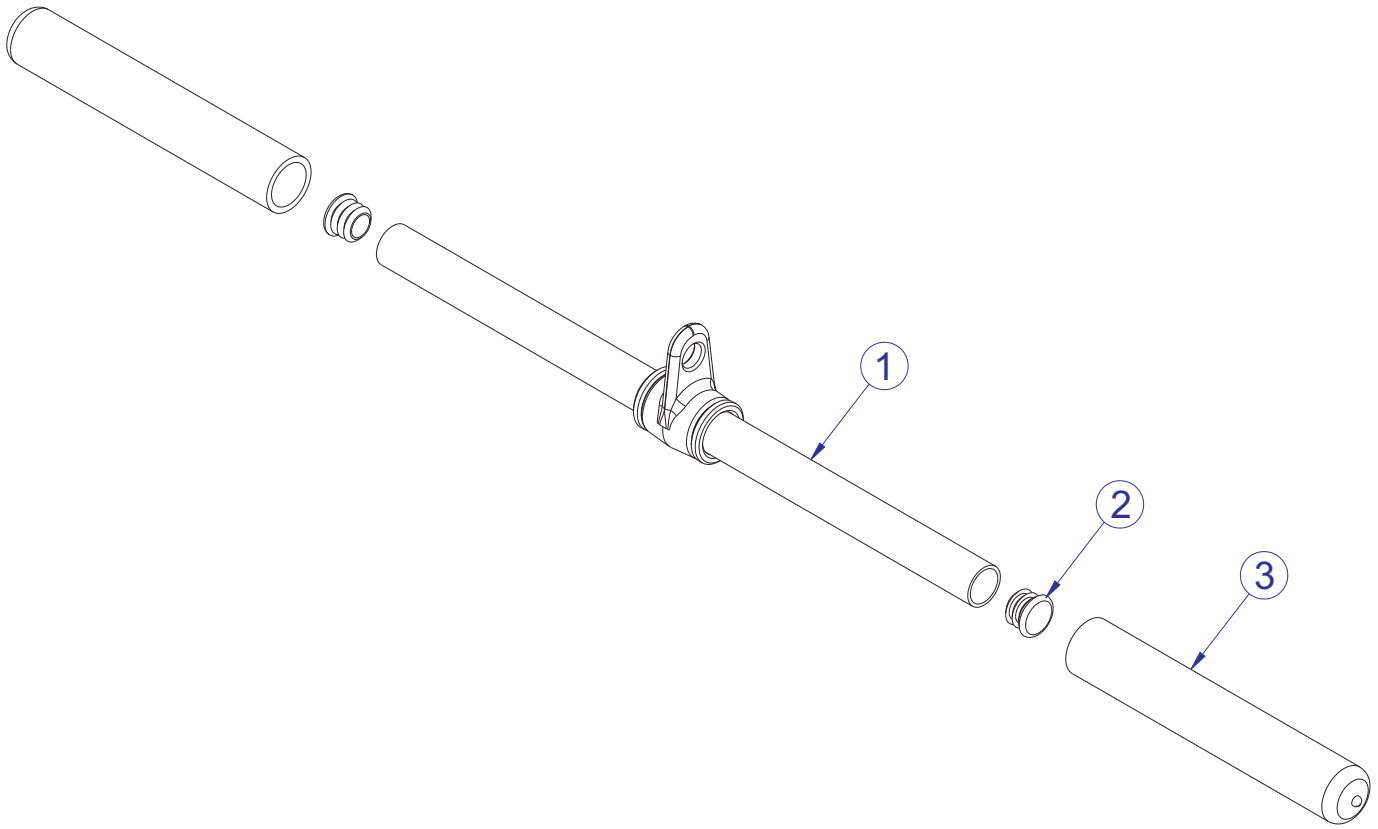

ITEM NO.	QTY.	PART NO.	DESCRIPTION
1	1	8588301	ASSY, LOW ROW BAR
2	2	3119304	CAP, END 1 DIA RD 10-12GA
3	2	8583101	GRIP, ROW BAR

G2-001 G2 HOME GYM HARDWARE BAG

HARDWARE BAG PART NUMBER

8607601

BAG CONTAINS:

Item	Description	UOM	Quantity
7014101	CABLE,SE,NB1-TP1,T1,151-7/8	EA	1
7014201	CABLE,SE-NB1,SE,143-1/4	EA	1
6409101	STRAP, ANKLE STANDARD	EA	1
3108002	CUSHION, WEIGHT STACK 3/4 ID	EA	2
3116201	PULLEY, 3-1/2 OD X 3/8 ID X 1	EA	12
3102924	3/8-16X1-3/4 UNS HEX FHB G2 ZN	EA	2
3102903	3/8-16 X 2-1/2 UNS HEX FHB G2 ZN	EA	1
3102904	3/8-16X3 UNS HEX FHB G2 ZN	EA	9
3102905	3/8-16 X 3-3/4 UNS HEX FHB G2 ZN	EA	15
3102968	3/8-16 X 8-3/4 UNS HEX FHB G2 ZN	EA	2
3102917	1/2-13X4 UNS HEX FHB G2 ZN	EA	1
3102971	1/2-13 X 8-3/8 UNS HEX FHB G2 ZN	EA	1
3102906	3/8-16X4 UNS HEX FHB G2 ZN	EA	2
3102807	NUT, NYLOCK 3/8-16 LOW HT	EA	28
3102804	NUT, NYLOCK 1/2-13 LOW HT	EA	1
3268201	NUT, LOCK 1/2 LOW HT	EA	1
3102514	WASHER, FLAT 3/8 IN SAE ST ZN	EA	24
3102512	WSHR, FLAT 1/2 ID X1-3/4 OD ZN	EA	2
8597601	WASHER, 1/2 RHCAP HOLDER	EA	2
8597701	SPACER, 3/8 X 1-1/2 LG	EA	2
8597801	SHAFT, 3/4 X 4	EA	1
8597702	SPACER, 3/8 X 1 LG	EA	4
3268001	SPACER, FLANGE 3/8 X 3/4	EA	2
3268101	SPACER, FLANGE 3/8 X 1-1/16	EA	8
3103302	SHAFT COLLAR, 13/16 ID ZINC	EA	2
3103801	LINK, SNAP 5/16 DIA	EA	3
8598001	AL CAP, ROLLER PAD END	EA	6
3268301	CAP SCREW, BTN HD 3/8-16 BO	EA	6
8610401	ALLEN WRENCH M5	EA	2
8598301	SILICONE GEL	EA	1
8599601	PAINT, TOUCH UP, SHADOW GREY	EA	1
8598401	PAINT, TOUCH UP, PLATINUM	EA	1
7308601	LABEL;WEIGHT STACK 1-26	EA	1
8598501	EXERCISE CARDS, G2	EA	8
8604201	MAGNET, CARD HOLDER	EA	2